



Breaking Speed Limits with GaN Power ICs

March 21st 2016

Dan Kinzer, COO/CTO

dan.kinzer@navitassemi.com

The Need for Speed

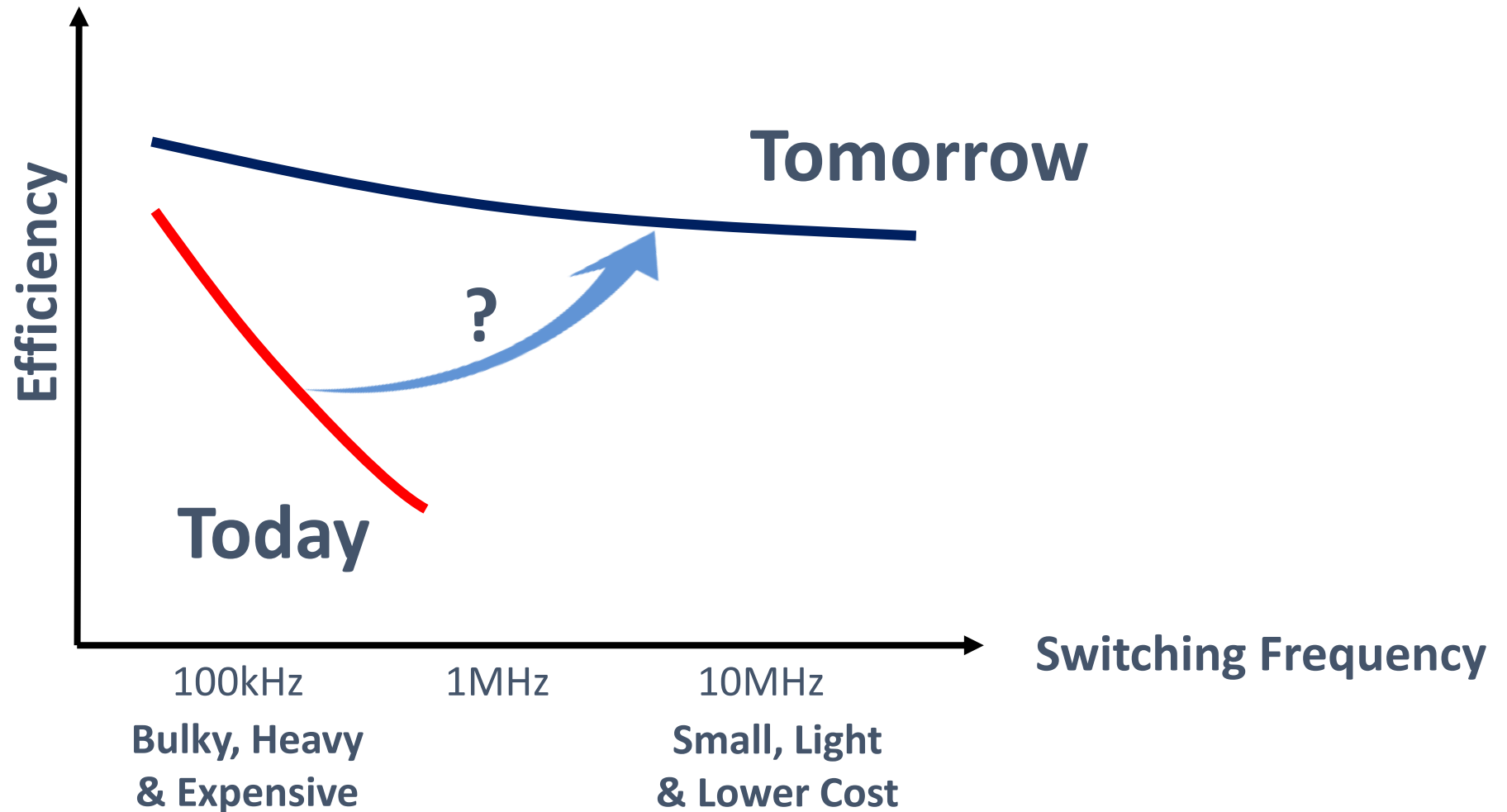

What is Slowing Us Down?



Wide Bandgap (WBG) Devices:

Physics Drives Switch Performance

- WBG GaN material allows high electric fields so high carrier density can be achieved
- Two dimensional electron gas with AlGaN/GaN heteroepitaxy structure gives very high mobility in the channel and drain drift region
- Lateral device structure achieves extremely low Q_g and Q_{OSS} and allows integration

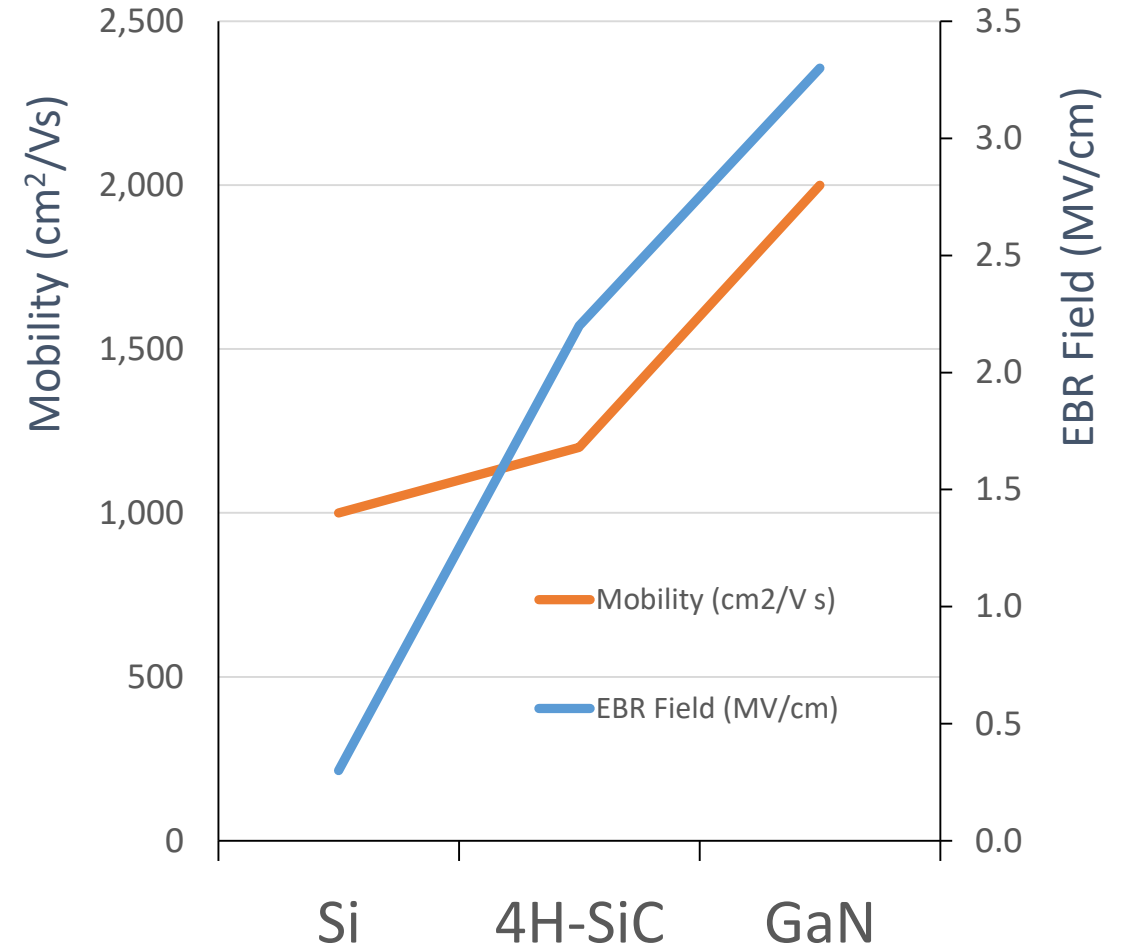
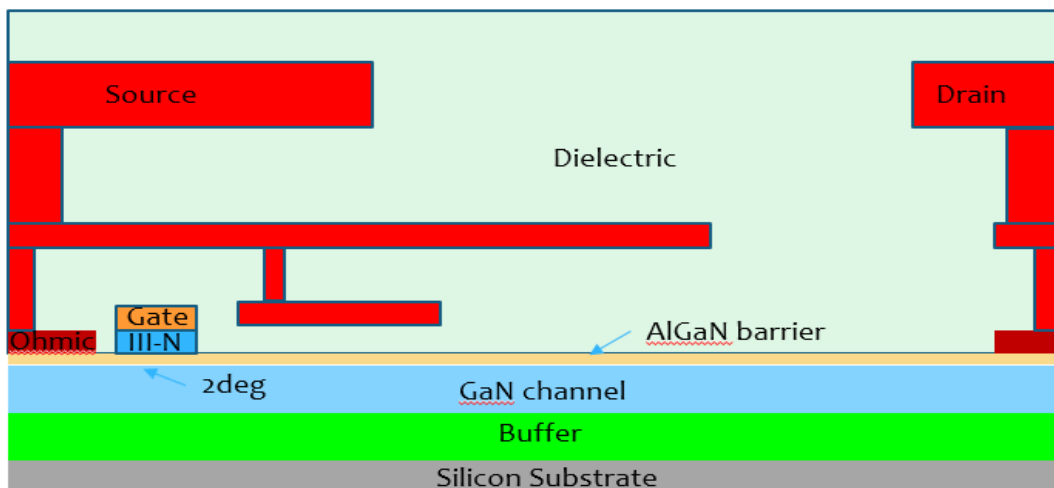

Speed Limit?

Can Magnetics Rise to the Speed Challenge?

- Boundaries vary with material, DC/AC current mix, power, etc.
- Majority of mass production applications run 65kHz – 150kHz
- 5x frequency increase is within today's capability

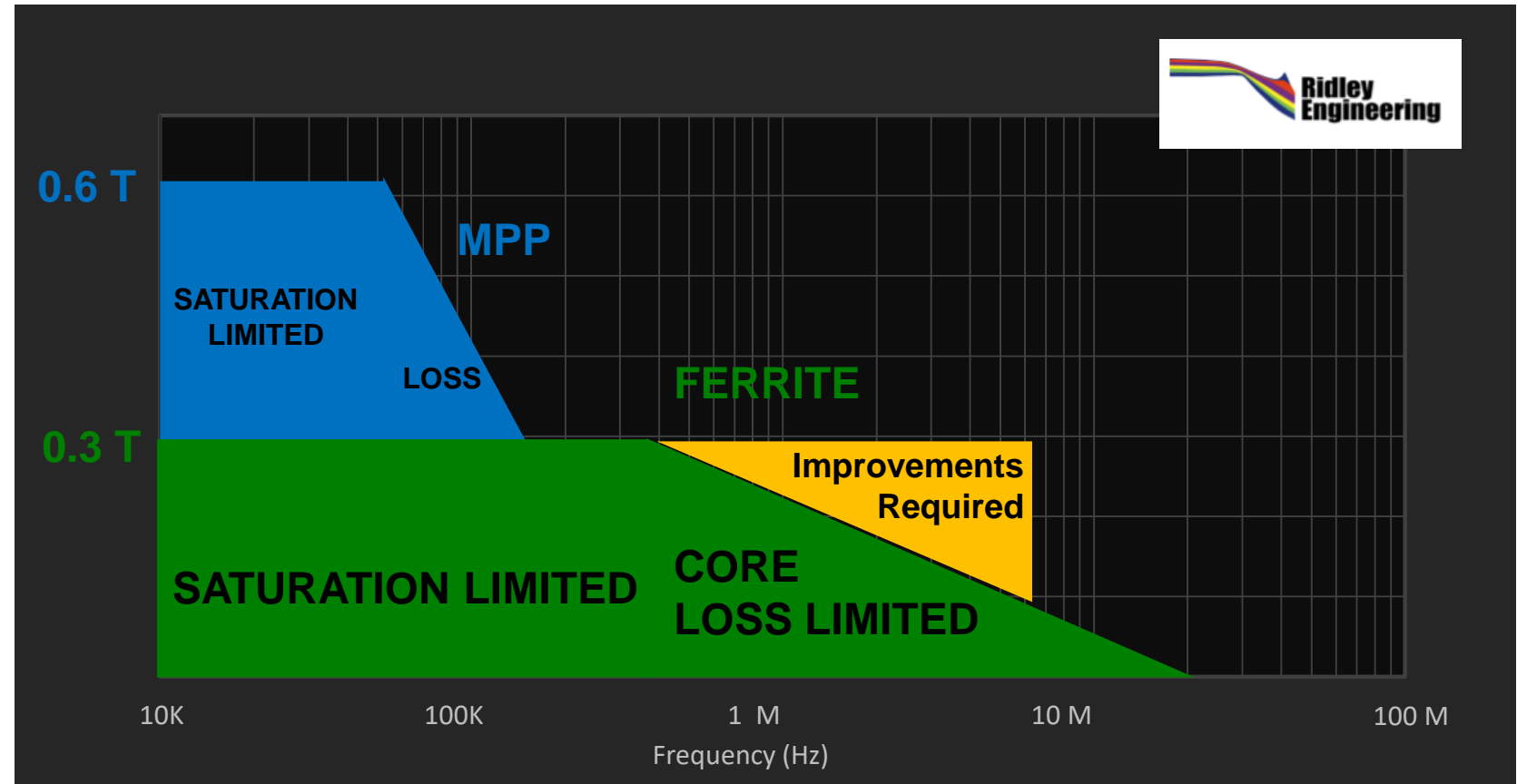

Removing speed limits:

High Frequency Magnetics 'GaN Optimized'

N59 optimized for 2MHz

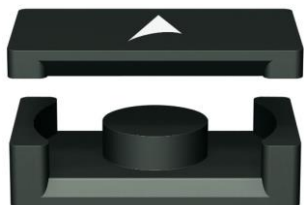
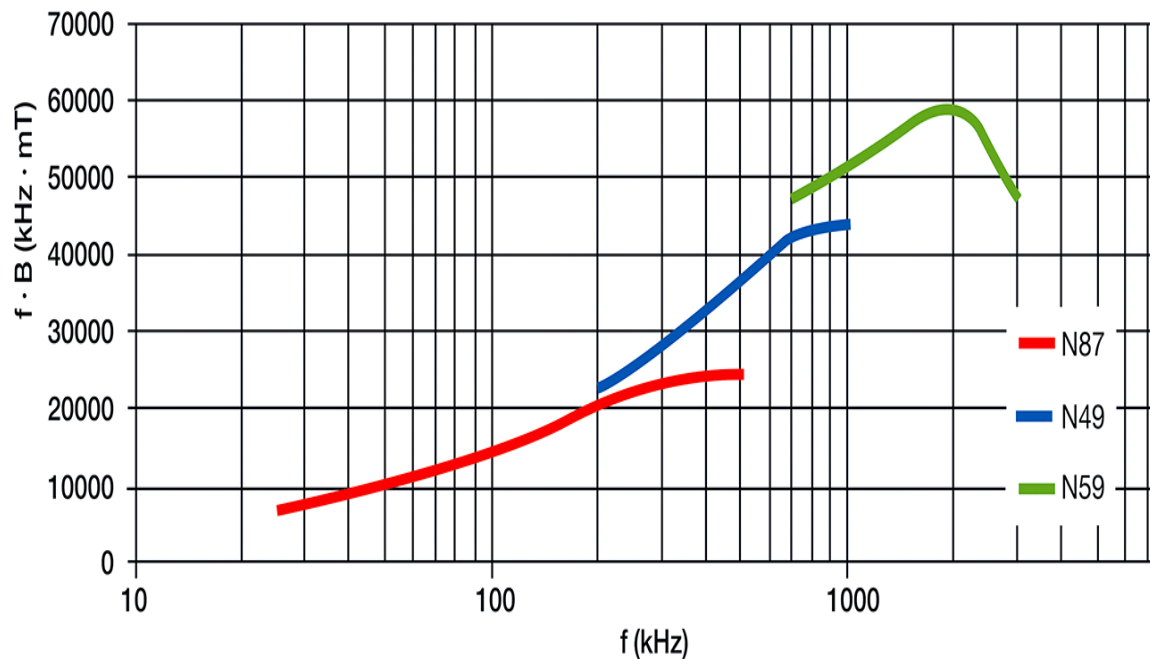

3F & 4F up to 10MHz

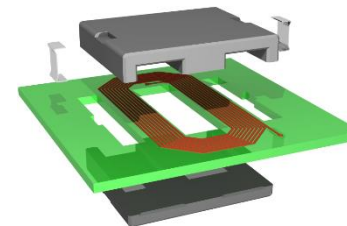
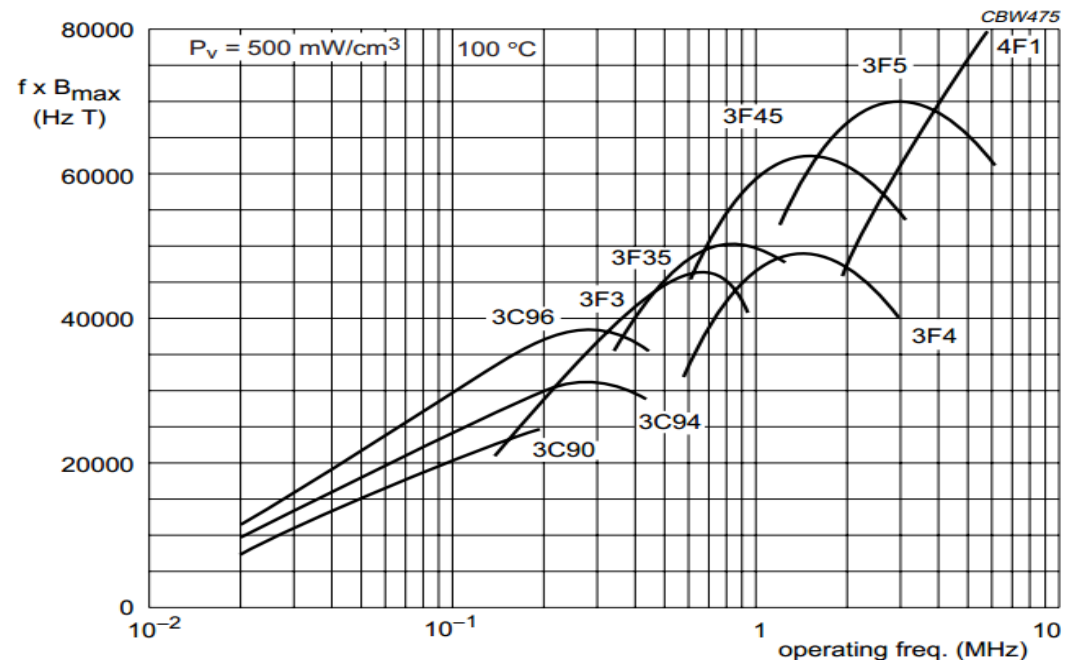

Breaking Speed Limits:

650V Navitas eMode GaN at 27MHz & 40MHz

Class Phi-2 DC/AC converter: Stanford / Navitas demo

- 50% less loss than RF Si
- 16x smaller package
- Air-core inductors
- Minimal FET loss
- Negligible gate drive loss

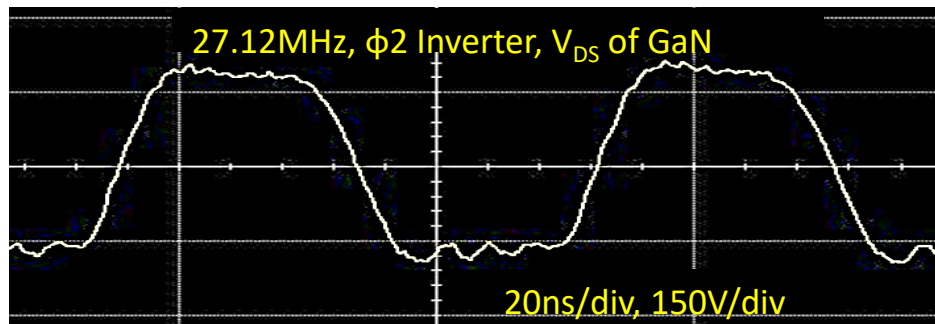
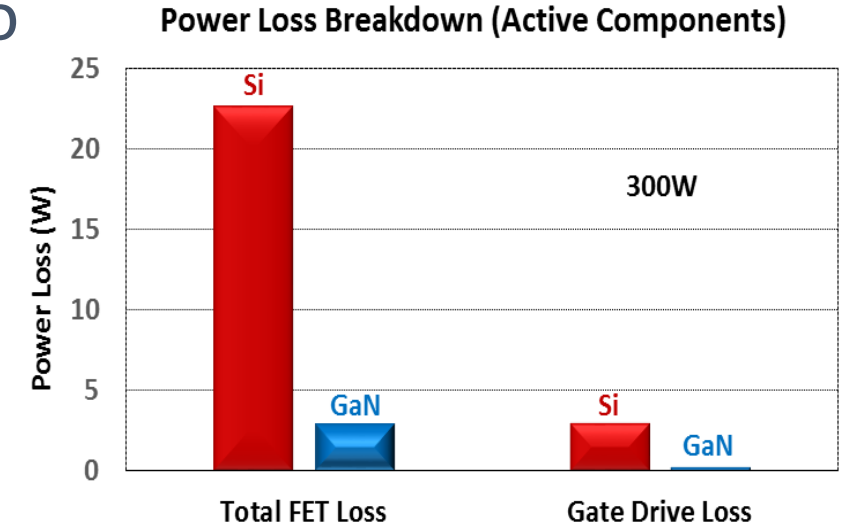
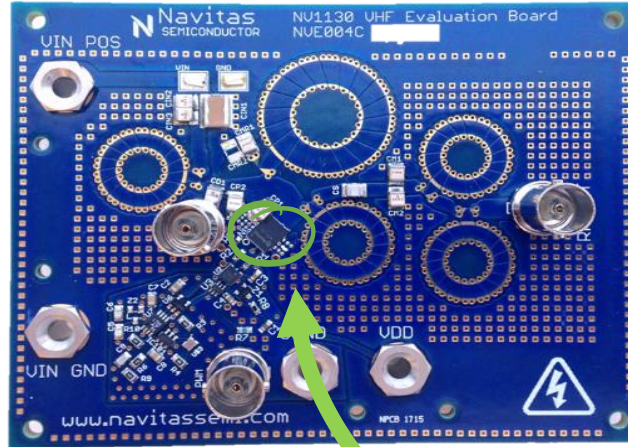
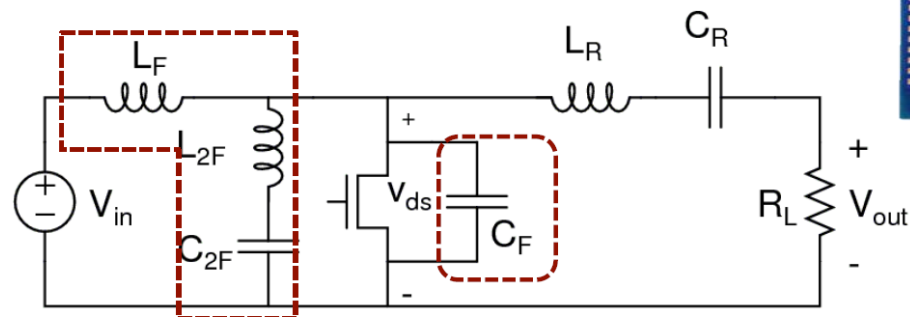

Technology	V	Pack (mm)	F_{sw} (MHz)	Eff. (%)	Power (W)
RF Si (ARF521) 	500	M174 22x22 	27.12	91%	150
eMode GaN 	650	QFN 5x6 	27.12	96%	150
			40.00	93%	115

Slow, Expensive, Non-Standard

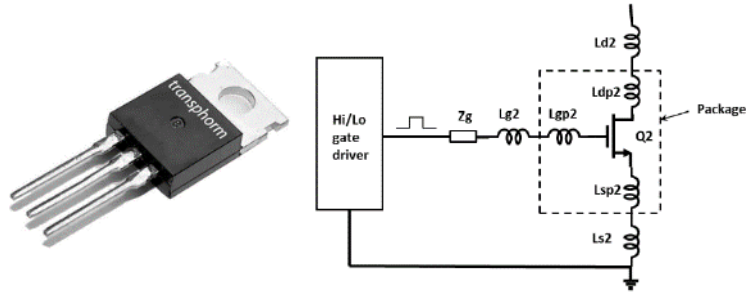

- **Through-hole**

- High inductance, limits switching frequency

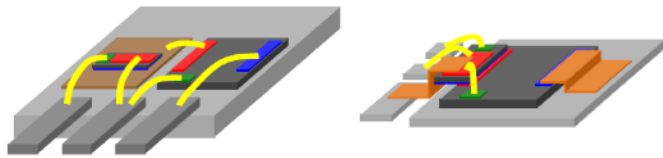

- **Cascode (co-pack and/or stacking)**

- Multi-die, additional components
- Higher cost for dice and assembly

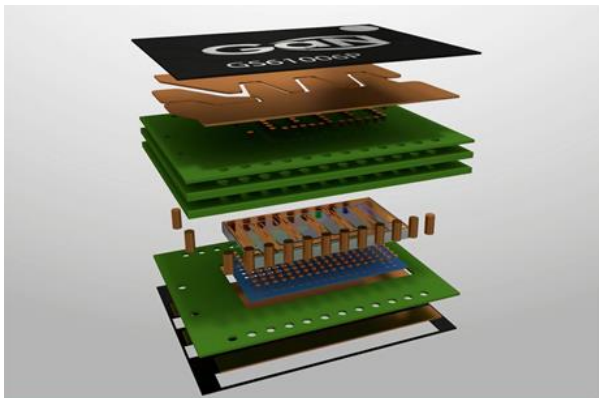

- **PCB-embedded**

- Non-standard, high cost

Removing Speed Limits:

Fast, Low Cost, Industry-Standard QFN

- Leadframe-based 5X6mm power package outline
- Low profile, small footprint with HV clearance
- Kelvin source connection for gate drive return
- Low inductance power connections ($\sim 0.2\text{nH}$)
- Low thermal resistance ($< 2^\circ\text{C/W}$)
- I/O pins enough for drive functions
- High volume
- Reliable
- Low cost

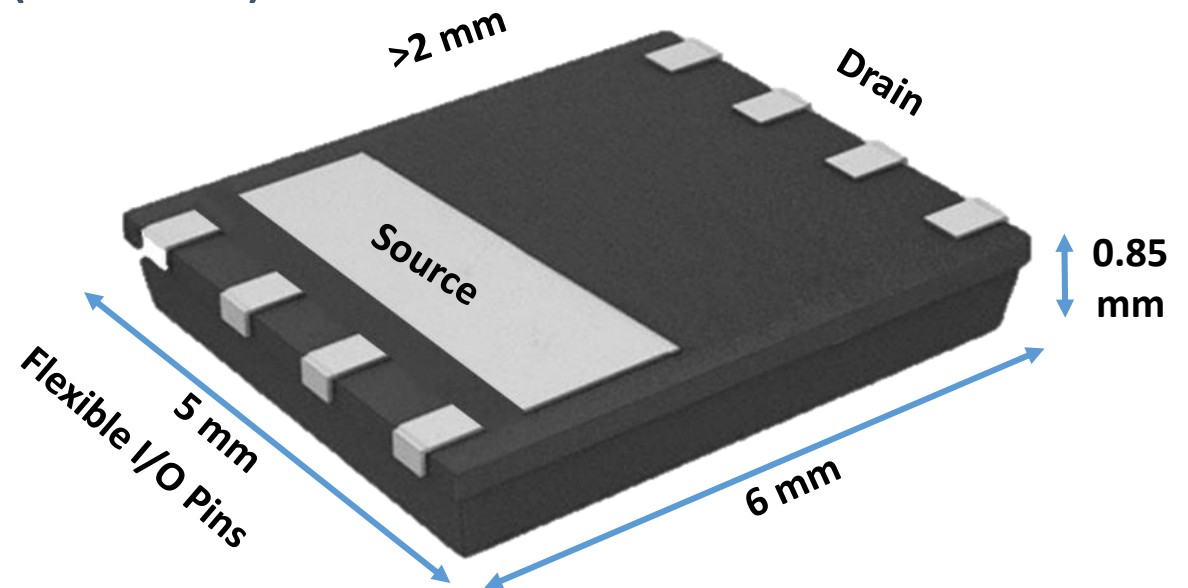

Speed Limit:

Complex Drive

- dMode GaN needs extra FET, extra passives, isolation, complex packaging
- Early eMode GaN requires many added circuits:

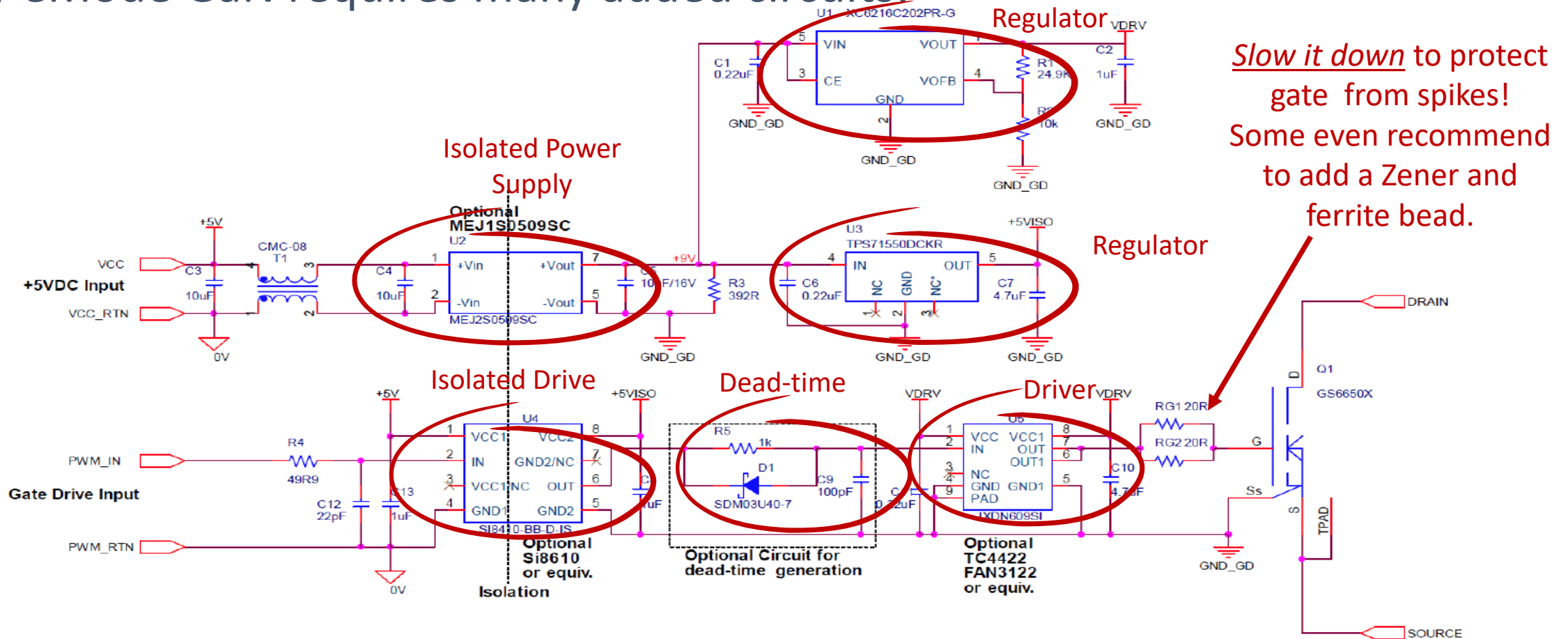

Creating the World's First AllGaN™ Power ICs

Fastest, most efficient
GaN Power FETs

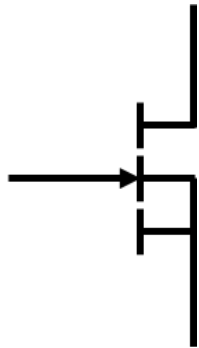

First & Fastest
Integrated GaN Gate Driver

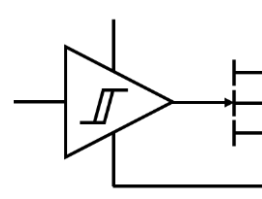

World's First
AllGaN™ Power IC

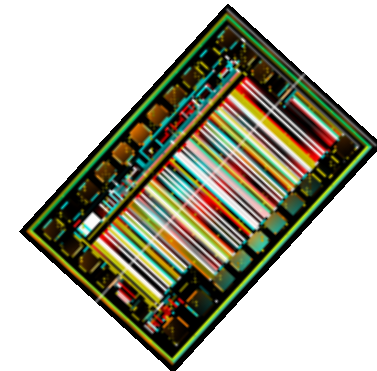

Up to 40MHz switching, 4x higher density & 20% lower system cost

Removing Speed Limits: Navitas GaN Power IC

- Monolithic integration
- 20X lower drive loss than silicon
- Driver impedance matched to power device
- Shorter prop delay than silicon (10ns)
- Zero inductance turn-off loop
- Digital input (hysteretic)
- Rail-rail drive output
- Layout insensitive

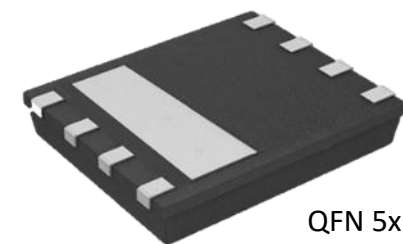
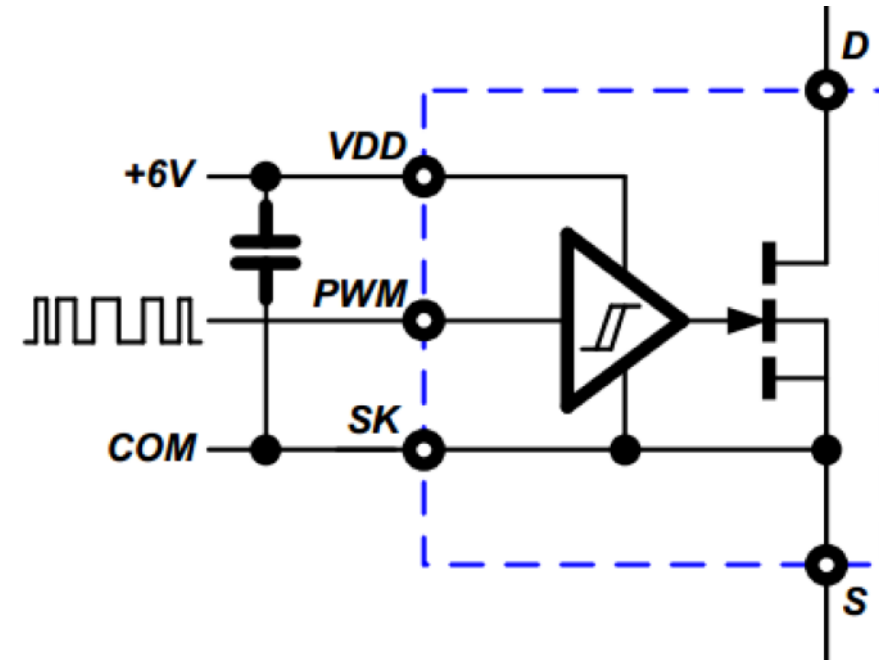

QFN 5x6mm

Crisp & Efficient Gate Control

- Eliminates gate overshoot and undershoot
- Zero inductance on chip insures no turn-off loss

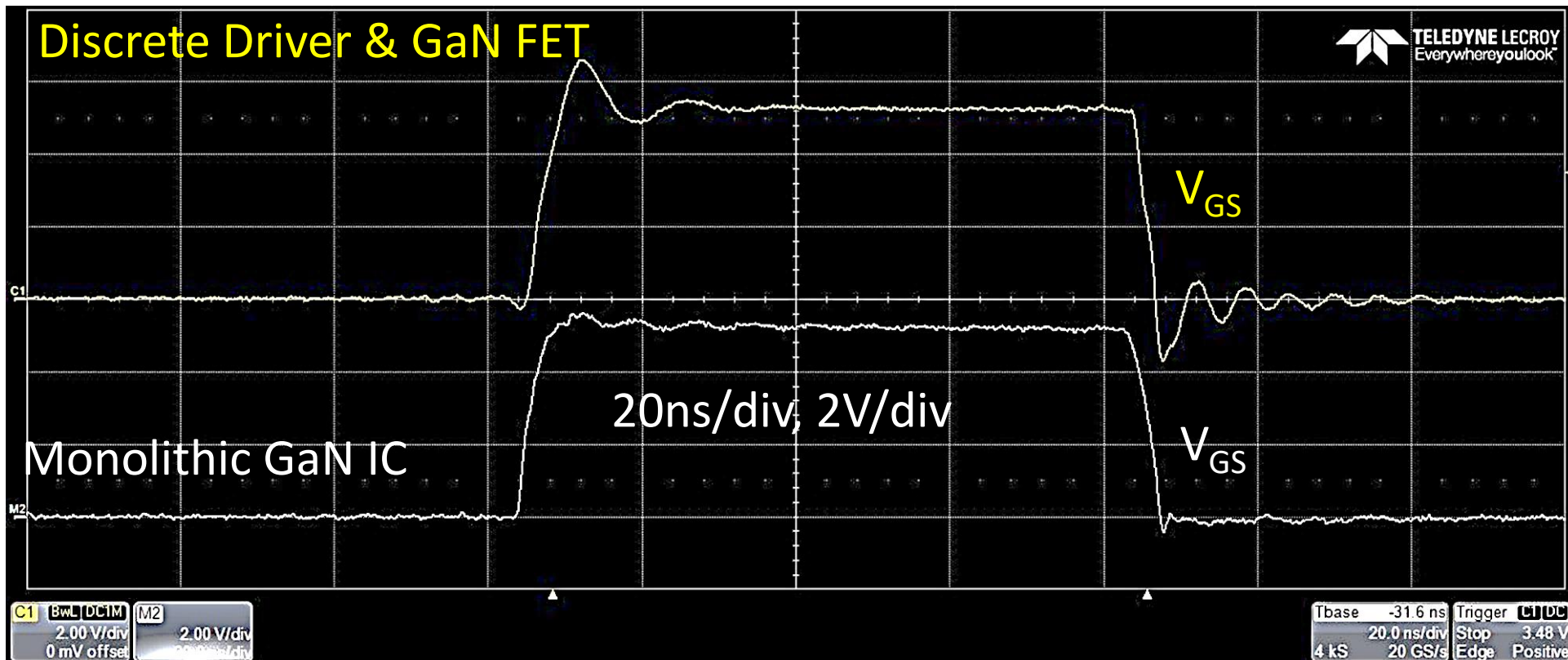

Primary Switch Power Loss:

$$P_{FET} = P_{COND} + P_{DIODE} + P_{T-ON} + P_{T-OFF} + P_{DR} + P_{QRR} + P_{QOSS}$$

Hard-Switch → Soft-Switch

Primary Switch Power Loss:

$$P_{FET} = P_{COND} * k + P_{DIODE} + \cancel{P_{T-ON}} + P_{T-OFF} + P_{DR} + P_{QRR} + P_{QOSS}$$

- k-factor >1 due to increased circulating current, duty cycle loss
- P_{T-On} = 0 (soft-switch)
- P_{Qoss} ↓2-3X (silicon devices can have high C_{OSS} charging/discharging losses)

Hard-Switch → Soft-Switch with eMode GaN

Primary Switch Power Loss:

$$P_{FET} = P_{COND} \overset{\text{Minimized}}{* k} + \overset{\text{Reduced}}{P_{DIODE}} + P_{T-ON} + P_{T-OFF} + P_{DR} + P_{QRR} + P_{QOSS}$$

- k-factor >1 due to increased circulating current, duty cycle loss
- P_{T-On} = 0 (soft-switch)
- P_{Qoss} ↓ 10X ~~2-3X~~ (GaN C_{OSS} charging/discharging loss negligible up to 2MHz)
- P_{DRIVER} ↓ 10X (GaN P_{DR} negligible up to 2MHz)
- P_{QRR} = 0
- P_{DIODE} ↓ 2X (reverse conduction loss reduced by synchronous rectification)
- P_{T-OFF} = Reduced (limited by I-V crossover loss due to drive loop impedence)

Hard-Switch → Soft-Switch with GaN Power IC

Primary Switch Power Loss:

$$P_{FET} = P_{COND} * k + P_{DIODE} + P_{T-ON} + P_{T-OFF} + P_{DR} + P_{QRR} + P_{QOSS}$$

Minimized Minimized
* k + P_{DIODE}

- k-factor >1 due to increased circulating current, duty cycle loss
- P_{T-On} = 0 (soft-switch)
- P_{Qoss} ↓ 10X ~~2-3X~~ (GaN C_{OSS} charging/discharging loss negligible up to 2MHz)
- P_{DRIVER} ↓ 10X (GaN P_{DR} negligible up to 2MHz)
- P_{QRR} = 0
- P_{DIODE} ↓ 3X ~~2X~~ (synchronous rectification with improved deadtime control)
- P_{T-OFF} = 0 ~~Reduced~~ (near-zero drive loop impedance with integration)

>10x frequency increase possible with higher efficiencies

No Bumps in the Road

EMI: Smooth, clean, controlled waveforms

- 500V Switching
- No overshoot / spike
- No oscillations
- 'S-curve' transitions
- ZVS Turn-on
- Zero Loss Turn-off
- Sync Rectification
- High frequency
- Small, low cost filter

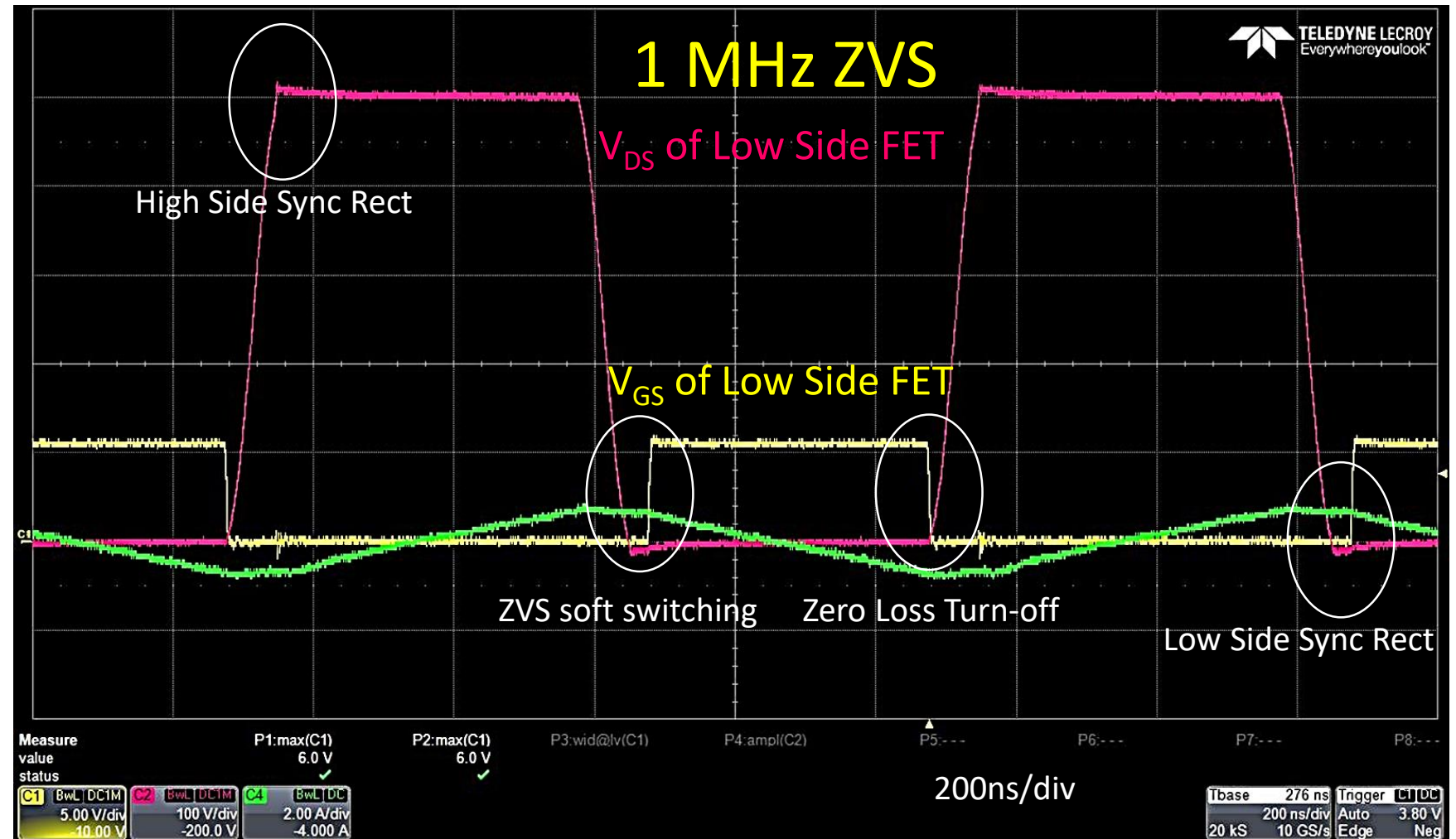

Removing speed limits:

MHz Controllers ... with more, faster to come



PFC (BCM):

- L6562 (1MHz)
- NCP1608 (1MHz)
- UCC28061 (500kHz)



DC-DC (LLC):

- NCP1395 (1.2MHz)
- FAN7688 (500kHz) (+SR)
- ICE2HS01G (1MHz)



DC-DC (Sync Rectifier):

- NCP4305 (1MHz)
- UCC24610 (600kHz)



PWM:

- NCP1252 (500kHz)
- NCP1565 (1.5MHz)
- UCC28C44 (1MHz)
- UCC25705 (4MHz)

DSP

- UCD3138 (2MHz)
- dsPIC33xx (5MHz)
- ADP1055 (1MHz)



SR FETs: Better with GaN

- All relevant FOMs favor GaN at 60V
- $R_{DS(ON)} \times Q_G$ reflects drive losses
- $R_{DS(ON)} \times Q_{OSS}$ reflects turn-off losses with non-resonant rectification
- $R_{DS(ON)} \times Q_{RR}$ reflects stored minority carrier turn-off losses
 - Minimized with deadtime control
- Silicon FETs are in QFN5X6 packages, GaN is WLCSP

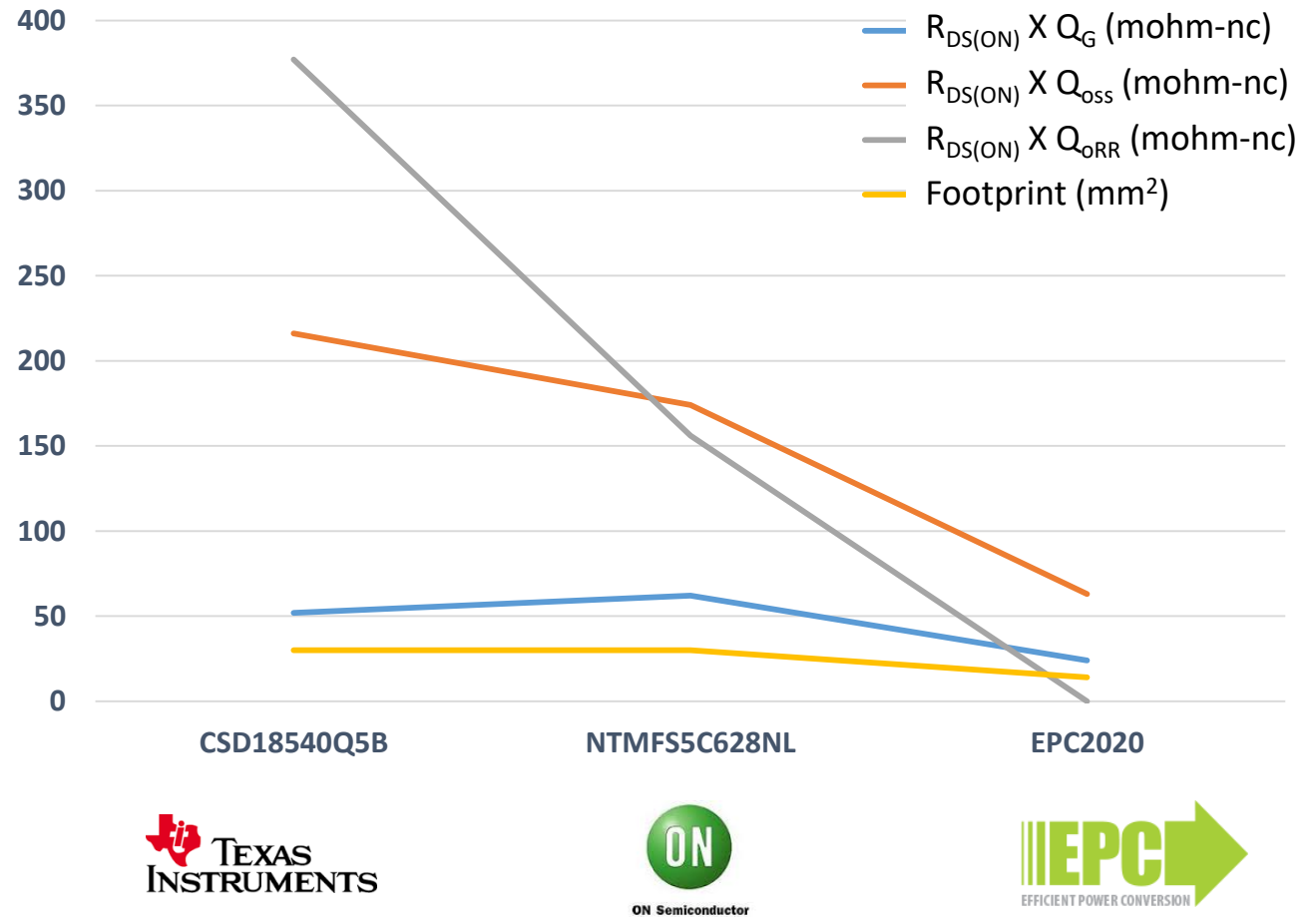

Note: Taken from datasheet typicals at 4.5/5V gate drive and capacitance curves

Speed test:

150W Boundary Conduction Mode (BCM) Boost PFC

- $120V_{AC} = 167\text{-}230\text{kHz}$
- $220V_{AC} = 230\text{-}500\text{kHz}$
- 265V peaks at 1MHz
PFC IC (L6562) $F_{SW} \text{ max}$

	Pack	$R_{DS(ON)}$ m Ω	Q_G nC	$C_{OSS(er)}$ pF	$C_{OSS(tr)}$ pF	$R*Q_G$ m Ω .nC	$R*C_{OSS(tr)}$ m Ω .pF	$R*C_{OSS(er)}$ m Ω .pF
Navitas	5x6	160	2.5	30	50	400	8,000	4,800
Si CP Series	8x8	180	32	69	180	5,760	32,400	12,400
Si C7 Series	8x8	115	35	53	579	4,025	66,600	6,100
GaN Benefits	>50%	n/a	>10x	>2x	>10x	>10x	>7x	>2.5x

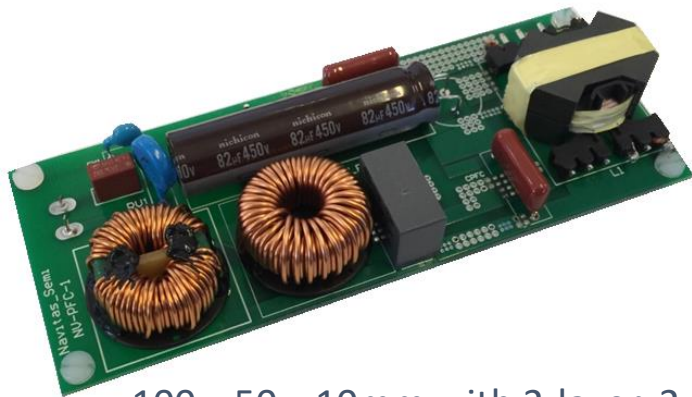

100 x 50 x 10mm with 2-layer, 2 oz Cu

No heatsinks, no forced air,
no glue, potting or heat spreaders

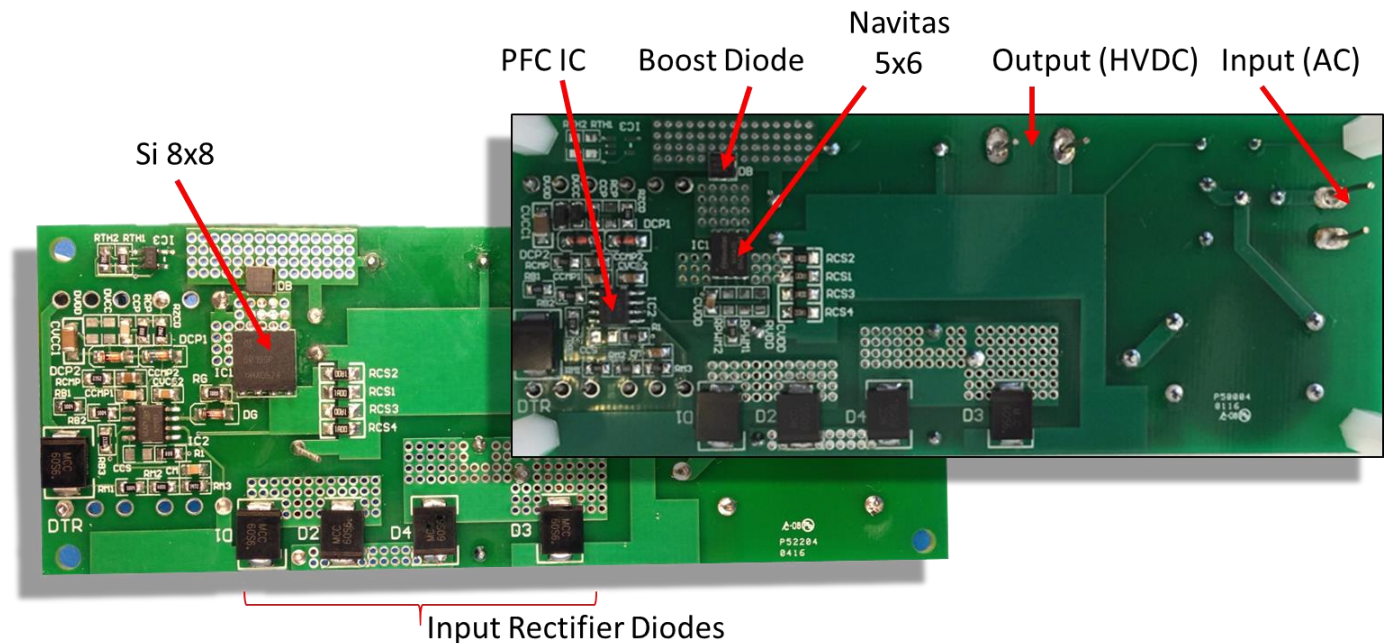

Silicon Hits the Soft-Switching Speed Limit

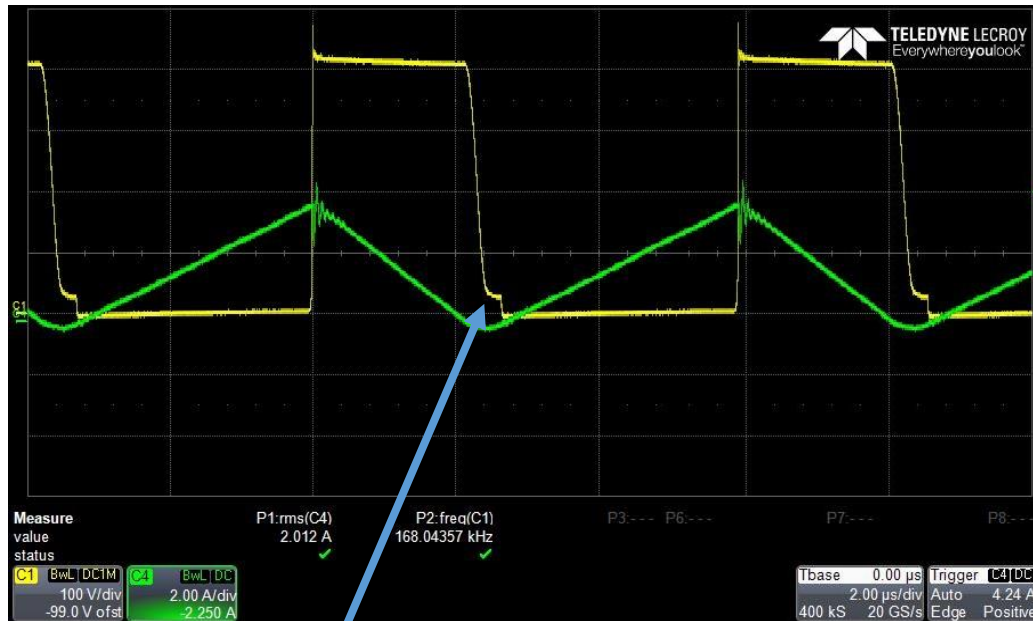

120V_{AC}, Si CP partial hard-switching (~200kHz)

- Si C_{OSS} is 50x-100x worse than GaN at V_{DS} < 30V
- High loss due to large stored charge while hard-switching

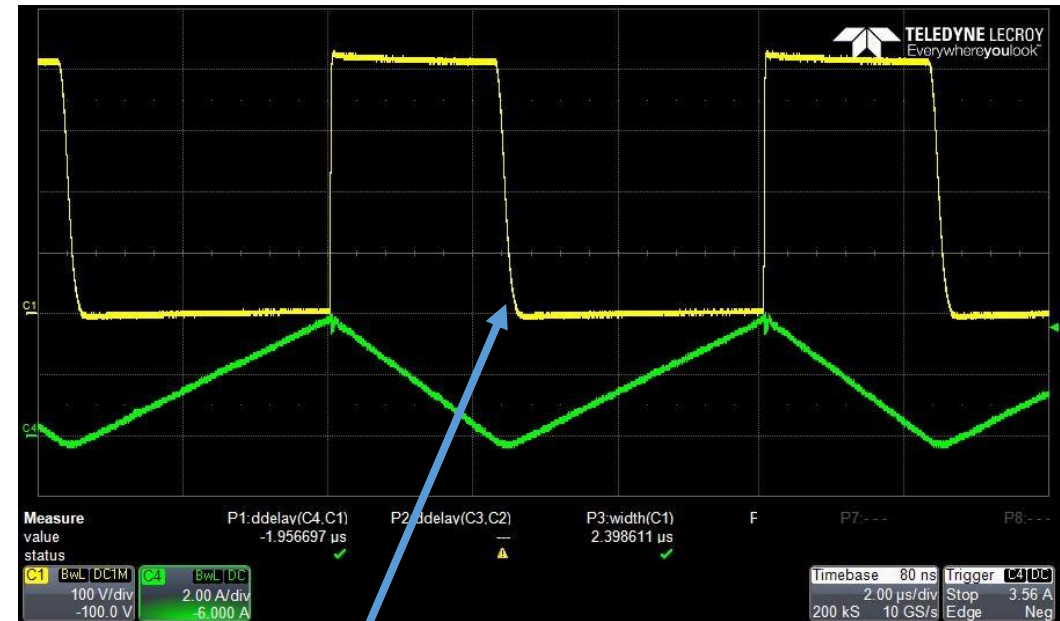

120V_{AC}, GaN clean ZVS waveforms (~200kHz)

- Turn-off losses are low due to powerful and parasitic-free drive integration with no overshoot
- Near loss-less ZVS turn-on transition
- Minimize deadtime for low reverse conduction loss

Silicon Hits a Speed Bump ... and GaN Drives On

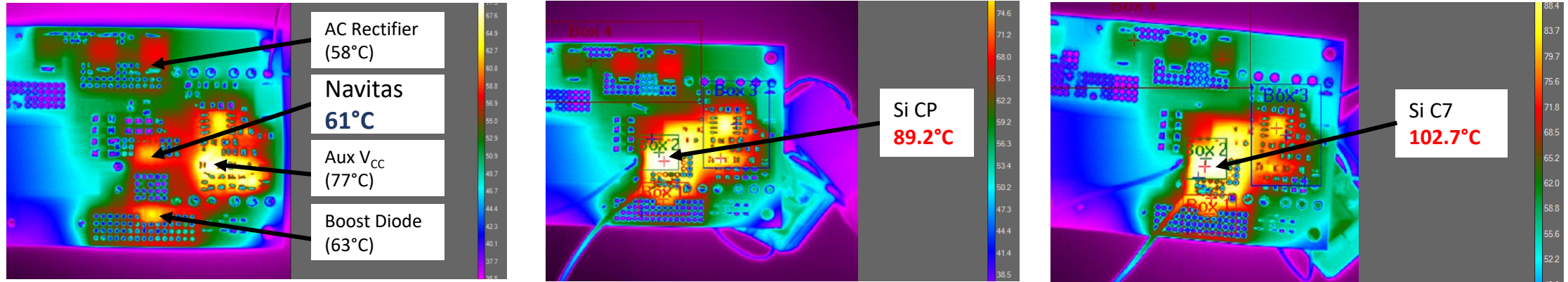

220V_{AC}, 150W

220V_{AC}, 150W

180V_{AC}, 150W

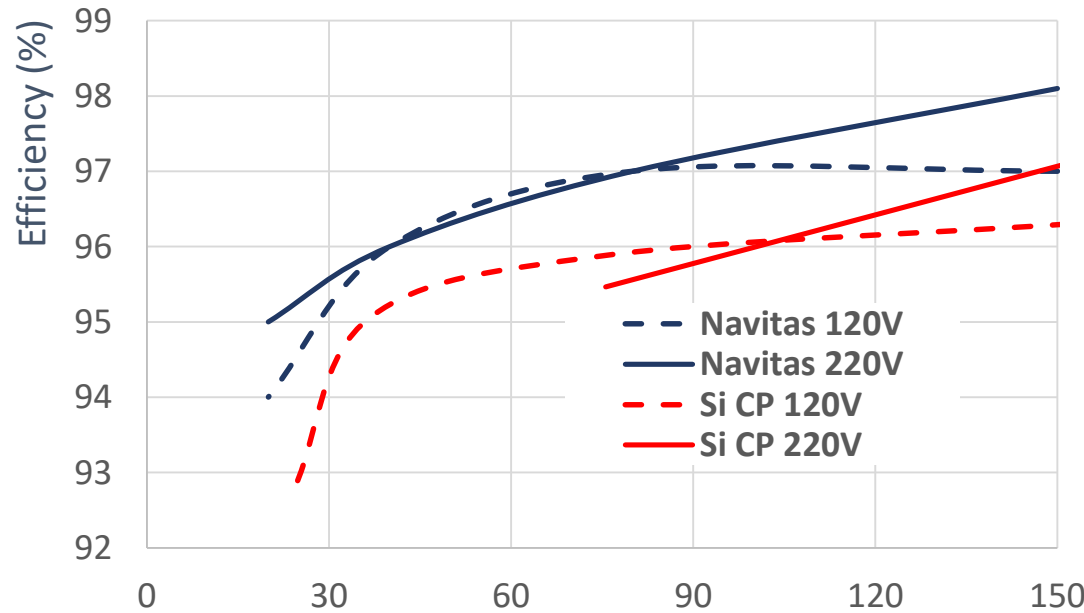

- ‘No heatsink’ design
- GaN runs cool
- Superjunction silicon FETs
 - Run 30-50°C hotter
 - Cannot deliver the power
 - Exhibit highly lossy resonant behavior

Output Power (W)

The Road Ahead...



Questions?

