

## ■ Handling notes of all pressure sensors

### • Please check the pressure medium.

Each product of our pressure sensors has different pressure medium compatibility. Select proper products after checking the materials of the components in contact with media.

### • Excessive pressure

Please do not apply pressure exceeding the maximum pressure as shown in the specifications/catalogs. The excessive pressure may affect the sensor characteristics and may make accurate measurement impossible.

### • Freezing

When the moisture on the sensor chip freezes, it may cause deformation or damage of the diaphragm. To avoid this, please be careful of the installation direction and the surrounding environment.

### • Effect of outside light

For the sensors without double diaphragm structure, care must be taken so that the light does not reach the sensor chip especially when transparent tubes are used. The sensor output may fluctuate when the sensor chip is exposed to the outside light.

### • Please check the specifications of the products.

Please make sure of the Pressure range, Power voltage, Output and Fitting. The misapplication may result in failure. Please also check the contents of the instruction manual if it's included, and keep it handy in order to look at it any-time when needed.

### • No entry/contact of foreign matter

A diaphragm is placed inside the pressure port. If foreign matter such as wire enters through the pressure port, damage could occur. So, this must be absolutely avoided. In the case of double diaphragm type, please avoid contact with the diaphragm or force solid matter into the diaphragm as it may deform the diaphragm and damage the sensor. Also care must be taken not to put foreign matter on the surface of the diaphragm.

### • Drip proof and moisture resistance

Please do not use sensors at anyplace where they are exposed to dripping water or oil, except drip proof type. In such a place, please put sensors in a case for protection. At the same time, in case of Gauge type (except the absolute pressure type), sensors must be open to the atmosphere. Even drip proof type is not compatible with submergence, an excessive liquid adhesion or an outdoor use, thus, please protect sensors by putting in a case. Please note that sensors must be open to the atmosphere in case of Gauge type. In the rapid temperature change, condensation may occur in the sensor. The use with the condensation may cause the following. - Internal circuits may be damaged or original characteristics are not maintained.

### • VR/Switch

Small size VRs are used for adjustment setting. So use a small screw driver with proper bit size.

# HANDLING NOTES

## PRESSURE SENSORS

### Reference data

#### Pressure medium compatibility by material

	SUS304	SUS316L	Hastelloy®	PP	PFA	PPS
Acetone	○	○	○	△	○	○
Ammonia water	○	○	○	○	○	△
Ethyl alcohol	○	○	○	○	○	○
Ferric chloride	×	×	△	○	○	○
Hydrochloric acid	×	×	△	○	○	○
Gasoline	○	○	○	○	○	○
Oxygen	○	○	○	○	○	○
Distilled water	○	○	○	○	○	○
Shaft lubricant	○	○	○	○	○	○
Carbon dioxide	○	○	○	○	○	○
Natural gas	○	○	○	○	○	○
Beer	○	○	○	○	○	○
Brake oil	○	○	○	○	○	○
Sulphuric acids	×	×	○	○	○	○
Hydrogen sulphide	×	×	○	○	○	○

The above table shows the compatibility of the pressure medium in general.

#### Recommended fittings

The following are recommended fittings to connect our pressure sensors (M5 female screw) to a urethan/nylon tube. (please contact the following manufacturer for the detail.)

Manufacturer	Appellation	Tube dimensions	
		φ 4 (2.5 × 4)	φ 6 (4 × 6)
Koganei Corporation	Quick Fitting	TS-4-M5	TS-6-M5
	Quick Fitting	TS-4-M5M	TS-6-M5M
	TAC Fitting	BF4	BF6
NIHON PISCO CO., Ltd.	Tube Fitting	PC4-M5	PC6-M5
	Tube Fitting	PC4-M5M	PC6-M5M
	Tube Fitting Minimal	LC-0425-M5	LC-0640-M5

# HANDLING NOTES

## PRESSURE SENSORS

### PROTECTIVE CONSTRUCTION

- Protective construction applies to the environment of sensor use. Regarding the pressure medium compatibility, please refer to each product specification.
- The protective construction aims at water protection. For the oil or various types of liquid, please be reminded that the degree of protection is different.
- The cable end of our pressure sensor is not waterproof. When handling, please pull out the cable to avoid penetration of water.

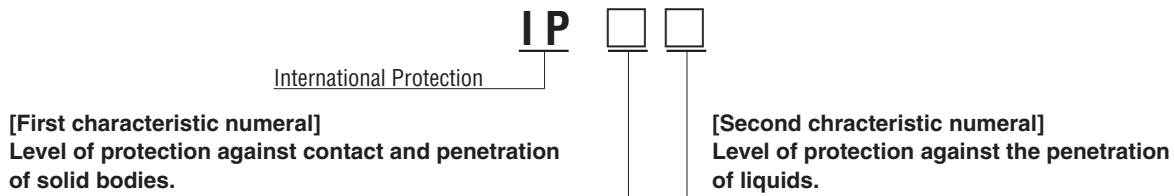

Grade	Degree of protection	
0		No protection
1		Protected against solid foreign objects such as hands of $\varnothing$ 50 mm and greater.
2		Protected against solid foreign objects such as finger of $\varnothing$ 12.5 mm and greater.
3		Protected against solid foreign objects such as tools or wires of ( $\varnothing$ or thickness of) 2.5mm and greater.
4		Protected against solid foreign objects such as tools or wires of ( $\varnothing$ or thickness of) 2.5mm and greater.
5		Protected against such dust as damages the equipment operation.
6		Dust-tight

**[Related standards]**  
IEC60529  
IEC (The International Electrotechnical Commission) standard  
IEC 60529  
Degrees of protection provided by enclosures

JIS-C-0920  
JIS(Japanese Industrial Standards ) standards JIC-C-0920  
Test to prove protection against ingress of water and degree of protection

Grade	Category	Degree of protection	
0			No protection
1	Drip-proof I type		Protected against vertically falling water drops.
2	Drip-proof II type		Protected against vertically falling water drops when enclosure is tilted up to 15°.
3	Rain-proof type		Protected against rainfall when enclosure is tilted up to 60°.
4	Splash-proof type		Protected against splashing water.
5	Water-jets-proof type		Protected against water jets.
6	Waterproof type		Protected against powerful water jets.
7	Watertight type		Protected against the effects of temporary immersion in water.
8	Underwater type		Protected against the effects of continuous immersion in water.

# HANDLING NOTES

## PRESSURE SENSORS

### ■ Electrical handling note

#### ● General

##### • Please turn off the power when wiring

When wiring or changing wire, please turn off the power. Care must be taken when checking operations by connecting wires with clips.

Please turn off the power when pulling out or putting on the connector as well.

Please make sure of appropriate wiring before turning on the power.

##### • Dedicated DC power is preferable

Please use stabilized DC power. We recommend that power supply for sensors should be different from power supply for actuator. In case of use of unit power supply, please earth the FG terminal. (Fig. 1)

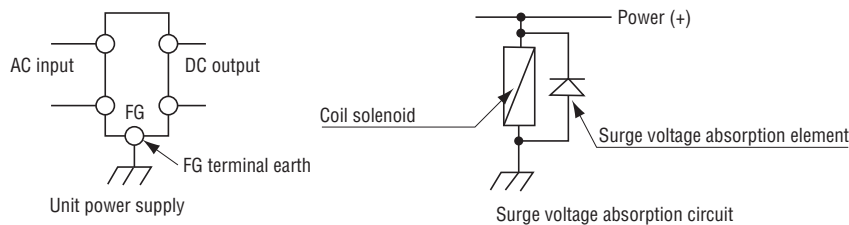

(Fig. 1)

##### • No electrical connections

N.C. (Non-connection) cables/terminals in Copal's sensors are provided in order to maintain the mechanical strength. Please avoid electrical connections.

##### • Wiring should be separated from power line

Sensor wiring should be separated from the other power lines or motors or heaters in order to protect sensors from electric field/magnetic field/surge voltage. Please do not bundle sensor wire with the other power line, and do not install sensor wire in the same conduit.

##### • Watch out for excessive switch output load

Please make sure the switch load does not exceed the specification value. Considering rush current or surge current, please try to reduce loads as much as possible. Electronic load such as PLC input is recommended. In the case of a relay or solenoid, please use one with a built-in surge voltage absorption circuit or please attach a surge voltage absorption circuit such as diode.

Please do not short circuit between switch output line and other lines.

# HANDLING NOTES

## PRESSURE SENSORS

### • Wiring for shield cable

If the sensor cable is shielded please handle as follows. Shield is to be cut at the receiving end (the side of power supply) when sensor itself is earthed through piping. Shield is to be earthed at the receiving end (the side of power supply) when sensor itself isn't earthed. When cable is extended, please use the same kind of shield. (Fig. 2)

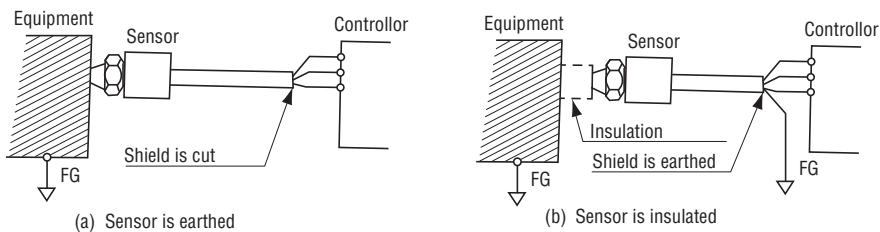

(Fig. 2)

### • Stability after power is applied

In case of pressure indicators, it may take approximately 1 second to the proper switch operation after power is applied. Thus, sequence, which is switchable from “ON” to “OFF” on power supply, should not be arranged. Much higher-performance can be expected for sensors with analog output, by taking 10 minutes' warm-up after power is applied.

### ● Handling notes of pressure transducers

#### • Main power

Fluctuations in the main power source will cause fluctuations in the output, so please use power source that matches the characteristics of the sensor. NIDEC COPAL ELECTRONICS's transducers are temperature-compensated to bring out the best characteristics when excited at 1.5 mA.

#### • Amplification circuitry

To sufficiently utilize transducer characteristics, use differential amplification circuitry considering input impedance, thermal error and common-mode voltage rejection ratio.

### ■ About lower limit of vacuum pressure range

While measuring the pressure in the range of vacuum by taking use of the pressure sensor (oil-enclosed type) as listed in the following table.

- Be attention that the the measurable pressure is limited to 1.3 kPa abs.
- For the measurement of pressure beyond the limitation, high-vacuum sensors such as thin film type are recommended.

#### Oil-enclosed type

The model	Pressure lower limit
P-8300,P-8305,P-8505,PA-750,PA-758,PA-800,PA-830,PA-838,PA-838-D,PA-840,PA-848,PA-850,PA-858,PS8,PS83,PS85,PG-35,PG-75,PG-208,PG-100B	1.3kPa abs

#### Thin film type

The model	Pressure lower limit
PA-920S,PA-928S,PA-930,PA-930-A,PS91,PG-20,PG-35L	1.4×10 <sup>-4</sup> kPa abs

# HANDLING NOTES

## PRESSURE SENSORS

---

---

---

---

---

---

---

---

### • Mounting on PCB

Mounting of pressure transducers on PCB should be made by manual soldering, and not by flow soldering nor by infrared reflow soldering.

To clean flux, please wipe it with a cloth dipped in a cleaning liquid. Please do not immerse the PCB in the cleaning liquid. Please pay attention so that vapor barrier agent, the flux, cleaning liquid and deoxidant etc. do not get inside the sensor or the atmospheric pressure vent hole.

Terminals are recommended to be soldered on PCB after proper positioning in order to prevent from mechanical stress on pressure port or on terminals. (Fig. 3)

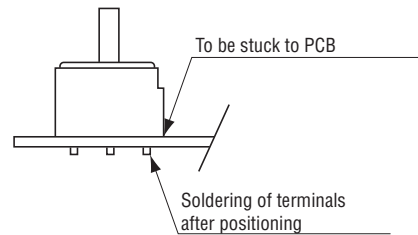

### • External force such as piping

Please be sure that excessive stress such as by piping or by fixed "O" ring is not exerted on the transducer terminals on the PCB.

### ● Pressure switch/Pressure Gauge

#### • Battery for PG-100, PG-200 and PG-208

When the voltage of the battery becomes low, the indication for battery change appears on the display. Please replace it accordingly. (Fig. 3)

When replacing batteries, use the designated battery. The product doesn't perform with alkaline battery offered commercially. This battery is not available on the market; therefore please contact a supplier of our product for ordering.

On handling, the following must be avoided; "dismantling batteries" "short-circuiting + and - end of batteries" "charging batteries" "heating batteries" "putting batteries into a fire". Consumed lithium battery should be discarded according to the local rules.

When not using the units for a long time, remove batteries from the units and store them in a dry and cool place.

### • External power

When using an external DC power source, use a stable power source. The series-regulator type power source unit is recommended rather than the switching-regulator type. Please take necessary measures to protect the product from external noise by grounding the FG terminal of the power supply.

### • Response

There are some products that have delay in the indication or analog output or products that are available to set delay (digital filter). Those products are not affected by the sudden pressure change, however due to this time lag, the pressure change may not be responded. Please check it in accordance with the intended use.

# HANDLING NOTES

## PRESSURE SENSORS

### ■ CE marking/List of series that conform to EMC directive

Series name	EMI directive	
	EMI standards	EMS standards
PG-100	EN55011	EN61000-6-1 (Transportable equipment)
PS6, PS20, PS30, PS60, PS91, PG-30, PG-35/35L, PZ-30 ※1, WL10, PG-75		EN61326-1 (Industrial equipment)
PA-20, PA-750, PA-758, PG-20, PA-920S/928S		EN61326-1, -2-3 (Industrial equipment, Pressure transducers)

For details on each standards, "EC Declaration of conformity" is available.

※ 1 : PZ-30 (Current output type) is not applicable.

### ■ UL products

Series name		File No.
Pressure transducers with AMP	PA-20, PA-750, PA-758, PA-830, PA-838, PA-920S/928S, PA-930	E222253
Pressure switches	PS20, PS30, PS60, PS83	
Pressure gauges	PG-20, PG-30, PG-35, PG-35H, PG-35L, PG-75	
Pressure indicators	PZ-30 ※ 1	
Liquid leak esnsors	WL10	E255230

※ 1 : PZ-30 (Current output type) is not applicable.

### ■ Calibration

#### ● List of series that can be calibrated

The following are series that can be calibrated.

"Calibration certificate", "Traceability system chart" and "Outgoing inspection result" are available (For value). As for the lead-time or the prices, please contact our sales office nearby or your local retailer.

- PG-100 series
- PG-100N series
- PG-100B series
- PG-200 series
- PG-208 series

# HANDLING NOTES

## PRESSURE SENSORS

### ■ Installation

#### • Installation to piping

When installing the sensor to a piping, turn the sensor by using a wrench on the hexagonal part. Please do not turn the sensor by holding the body (especially at the plastic housing).

#### • Handling of taper screw thread

In case of joint of taper screw thread, please screw into the fitted pipe, winding the sealing tape on the screw part. In this case, the seal tape should be wound gaping for 2 threads from the head of thread. If the seal tape is wound from the head of thread, a piece of seal tape may go into the piping. Please screw the joint, after the seal tape is pressed down until the tape fits in the screw.

Please refer to the tightening torque as follows. (Fig. 4)

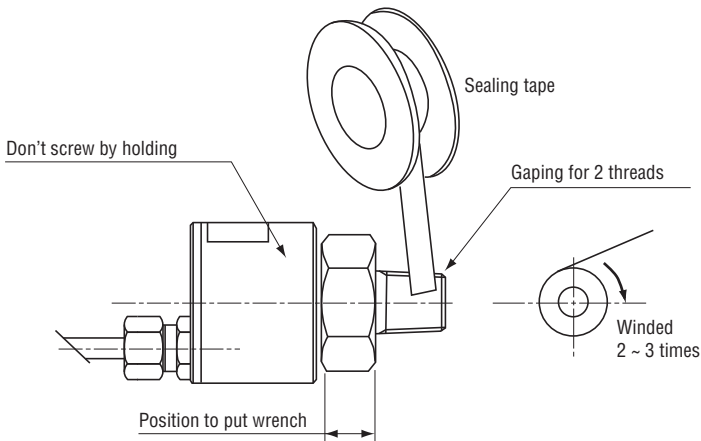

(Fig. 4)

Screw figure	N·m Tightening torque
R 1/8	7 ~ 9
R 1/4	12 ~ 14
R 3/8	22 ~ 24
M 5	1.0 ~ 1.5

#### • Surge pressure

A sudden surge pressure may occur in the liquid piping such as water. When sensors get pressure from the piping, it may cause a damage on the sensor chip. It is the best way to hold the pressure under control as the surge pressure may give damage in the piping. If there is still a possibility of occurrence, we recommend the use of a diaphragm apparatus or an accumulator in order to prevent from the damage of sensors.

Another method may work such as to lengthen the distance of piping or to change the direction of mounting as well. (Fig. 5)

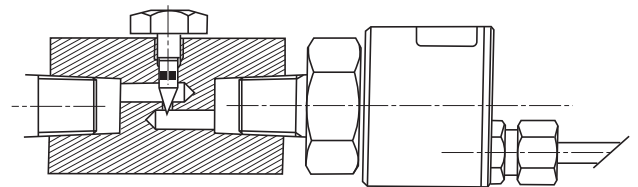

Measure for surge pressure

(Fig. 5)

# HANDLING NOTES

## PRESSURE SENSORS

### ■ PRESSURE CONVERSION TABLE

	Pa(N/m <sup>2</sup> )	kPa	MPa	bar	mbar(hPa)	kgf/cm <sup>2</sup>	mmH <sub>2</sub> O(mmAq)	inH <sub>2</sub> O	mmHg(Torr)	inHg	psi	atm
Pa(N/m <sup>2</sup> )	1	1 × 10 <sup>-3</sup>	1 × 10 <sup>-6</sup>	1 × 10 <sup>-5</sup>	1 × 10 <sup>-2</sup>	1.01972 × 10 <sup>-5</sup>	1.01974 × 10 <sup>-1</sup>	4.01474 × 10 <sup>-3</sup>	7.50062 × 10 <sup>-3</sup>	2.95300 × 10 <sup>-4</sup>	1.45038 × 10 <sup>-4</sup>	9.86923 × 10 <sup>-6</sup>
kPa	1 × 10 <sup>3</sup>	1	1 × 10 <sup>-3</sup>	1 × 10 <sup>-2</sup>	1 × 10	1.01972 × 10 <sup>-2</sup>	1.01974 × 10 <sup>2</sup>	4.01474	7.50062	2.95300 × 10 <sup>-1</sup>	1.45038 × 10 <sup>-1</sup>	9.86923 × 10 <sup>-3</sup>
MPa	1 × 10 <sup>6</sup>	1 × 10 <sup>3</sup>	1	1 × 10	1 × 10 <sup>4</sup>	1.01972 × 10	1.01974 × 10 <sup>5</sup>	4.01474 × 10 <sup>3</sup>	7.50062 × 10 <sup>3</sup>	2.95300 × 10 <sup>2</sup>	1.45038 × 10 <sup>2</sup>	9.86923
bar	1 × 10 <sup>5</sup>	1 × 10 <sup>2</sup>	1 × 10 <sup>-1</sup>	1	1 × 10 <sup>3</sup>	1.01972	1.01974 × 10 <sup>4</sup>	4.01474 × 10 <sup>2</sup>	7.50062 × 10 <sup>2</sup>	2.95300 × 10	1.45038 × 10	9.86923 × 10 <sup>-1</sup>
mbar(hPa)	1 × 10 <sup>2</sup>	1 × 10 <sup>-1</sup>	1 × 10 <sup>-4</sup>	1 × 10 <sup>-3</sup>	1	1.01972 × 10 <sup>-3</sup>	1.01974 × 10	4.01474 × 10 <sup>-1</sup>	7.50062 × 10 <sup>-1</sup>	2.95300 × 10 <sup>-2</sup>	1.45038 × 10 <sup>-2</sup>	9.86923 × 10 <sup>-4</sup>
kgf/cm <sup>2</sup>	9.80665 × 10 <sup>4</sup>	9.80665 × 10	9.80665 × 10 <sup>-2</sup>	9.80665 × 10 <sup>-1</sup>	9.80665 × 10 <sup>2</sup>	1	1.00003 × 10 <sup>4</sup>	3.93712 × 10 <sup>2</sup>	7.35559 × 10 <sup>2</sup>	2.89590 × 10	1.42233 × 10	9.67841 × 10 <sup>-1</sup>
mmH <sub>2</sub> O(mmAq)	9.80638	9.80638 × 10 <sup>-3</sup>	9.80638 × 10 <sup>-6</sup>	9.80638 × 10 <sup>-5</sup>	9.80638 × 10 <sup>-2</sup>	9.99972 × 10 <sup>-5</sup>	1	3.93701 × 10 <sup>-2</sup>	7.35559 × 10 <sup>-2</sup>	2.89582 × 10 <sup>-3</sup>	1.42229 × 10 <sup>-3</sup>	9.67814 × 10 <sup>-5</sup>
inH <sub>2</sub> O	2.49082 × 10 <sup>2</sup>	2.49082 × 10 <sup>-1</sup>	2.49082 × 10 <sup>-4</sup>	2.49082 × 10 <sup>-3</sup>	2.49082	2.53993 × 10 <sup>-3</sup>	2.54000 × 10	1	1.86827	7.35539 × 10 <sup>-2</sup>	3.61263 × 10 <sup>-2</sup>	2.45825 × 10 <sup>-3</sup>
mmHg(Torr)	1.33322 × 10 <sup>2</sup>	1.33322 × 10 <sup>-1</sup>	1.33322 × 10 <sup>-4</sup>	1.33322 × 10 <sup>-3</sup>	1.33322	1.35951 × 10 <sup>-3</sup>	1.35955 × 10	5.35255 × 10 <sup>-1</sup>	1	3.93701 × 10 <sup>-2</sup>	1.93368 × 10 <sup>-2</sup>	1.31579 × 10 <sup>-3</sup>
inHg	3.38639 × 10 <sup>3</sup>	3.38639	3.38639 × 10 <sup>-3</sup>	3.38639 × 10 <sup>-2</sup>	3.38639 × 10	3.45316 × 10 <sup>-2</sup>	3.45325 × 10 <sup>2</sup>	1.35955 × 10	2.54000 × 10	1	4.91154 × 10 <sup>-1</sup>	3.34211 × 10 <sup>-2</sup>
psi	6.89476 × 10 <sup>3</sup>	6.89476	6.89476 × 10 <sup>-3</sup>	6.89476 × 10 <sup>-2</sup>	6.89476 × 10	7.03070 × 10 <sup>-2</sup>	7.03089 × 10 <sup>2</sup>	2.768076 × 10	5.17149 × 10	2.03602	1	6.80460 × 10 <sup>-2</sup>
atm	1.01325 × 10 <sup>5</sup>	1.01325 × 10 <sup>2</sup>	1.01325 × 10 <sup>-1</sup>	1.01325	1.01325 × 10 <sup>3</sup>	1.03323	1.03326 × 10 <sup>4</sup>	4.06794 × 10 <sup>2</sup>	7.60000 × 10 <sup>2</sup>	2.99213 × 10	1.46960 × 10	1

※ The data is for reference.

### ■ PRESSURE REFERENCE

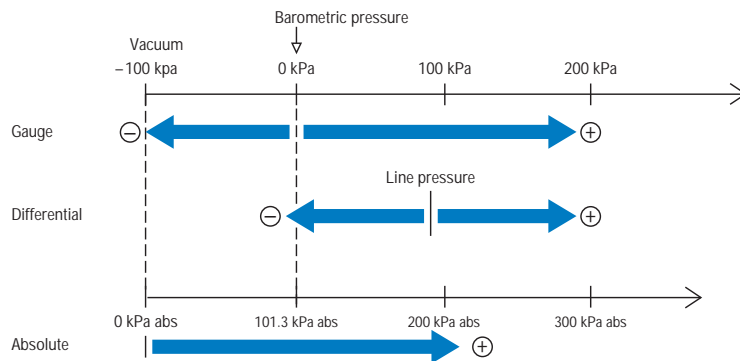

#### ● Gauge pressure

The gauge pressure is measured by the difference from atmospheric pressure on the basis of the atmospheric pressure. The vacuum pressure (negative pressure) is displayed in minus. The pressure is used for the measurement of degree of pressurization by compressor or by hydraulic equipment, the measurement of degree of high vacuum by ejector, the confirmation of the vacuum suction or the confirmation of ambient pressure in a vacuum chamber.

#### ● Absolute pressure

The absolute pressure is measured by the difference from absolute vacuum as the basis. The absolute pressure, that isn't affected by the fluctuation caused by the condition of atmosphere or altitude, is used for the measurement of atmosphere, altitude, water depth, or degree of vacuum.

**Please consult us in case of use in the high vacuum.**

#### ● Differential pressure

The differential pressure is measured by the difference of pressure between 2 ports. It is measured on the basis of either pressure. The pressure is used for the measurement of flow rate, the check of clogged filter or leak test.

#### ● Compound pressure is a pressure ranged from

Negative(vacuum) to positive(gauge) pressure. Pressure sensor for compound pressure alone can measure both positive and negative pressure, useful for application like a pump whose pressure can be either vacuum or positive.